

## Type CARTRIDGE

Plug valves with cartridge

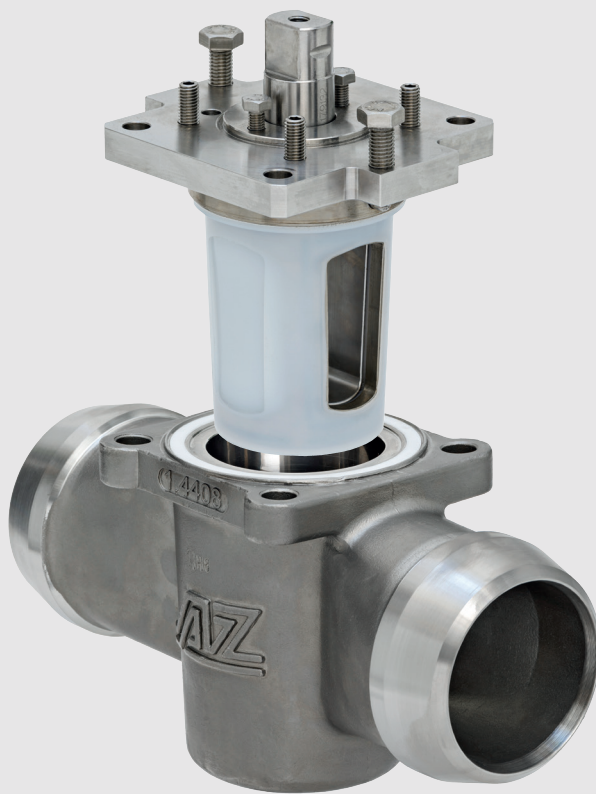

# Type CARTRIDGE / CARTRIDGE-N

## Plug valve with exchangeable cartridge



- in-line repair on welded valves
- fast replacement of the cartridge during maintenance

DN 50 - 600 / PN 10 - 100  
NPS 2 - 24 / Class 150 600

Range of application:

$-60 < T < 80^{\circ}/210^{\circ}\text{C}$

vacuum-capable

### Design characteristics

- cage covered by robust PFA / UHMW-PE sleeve
- cold-flow eliminated by supporting ribs
- cartridge for 2-way or 3-way valves (vertical)
- maintenance-free / self-lubricating
- actuator mounting flange acc. to ISO 5211
- easily accessible plug adjustment
- vacuum-capable

### Options

- special materials for body and sleeve
- full bore (CARTRIDGE-EXTRA)
- heating jacket
- multiport plug valve

### Type CARTRIDGE

cast design plug valve  
with weld-ends

Remote  
maintainable



concrete  
shield

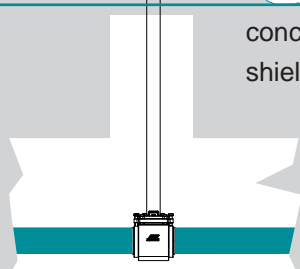

PT diagram, plug types, sealing systems, material selection: see catalogue part ENGINEERING

# Fast service for welded plug valves

## Optimization of in-line service

### Type CARTRIDGE-N

forged steel plug valve  
with welding-ends and aligning pins



### Type CARTRIDGE-N

Block design with special cartridge  
for fast service

- body made of forged or bar-stock material
- no incorrect installation due to aligning pins (type CARTRIDGE-N)
- no special tooling
- maintenance possible for valves which are difficult to access

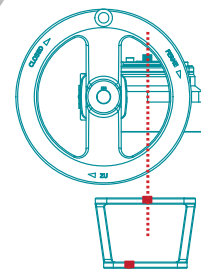

### Fast replacement of cartridge

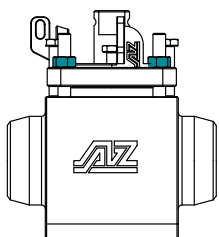

loosen the cover nuts

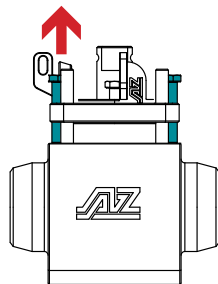

lift the cartridge with the  
jacking screws

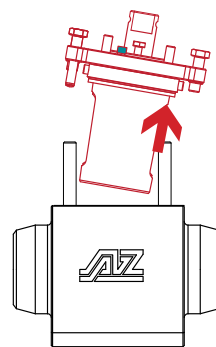

remove the old  
cartridge

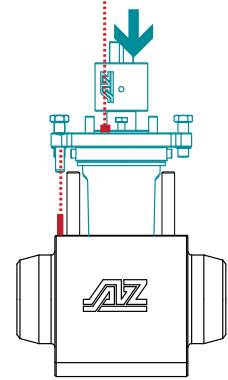

assembly of all parts  
with aligning pins

# Pre-assembled cartridge

## Fast and trouble-free replacement

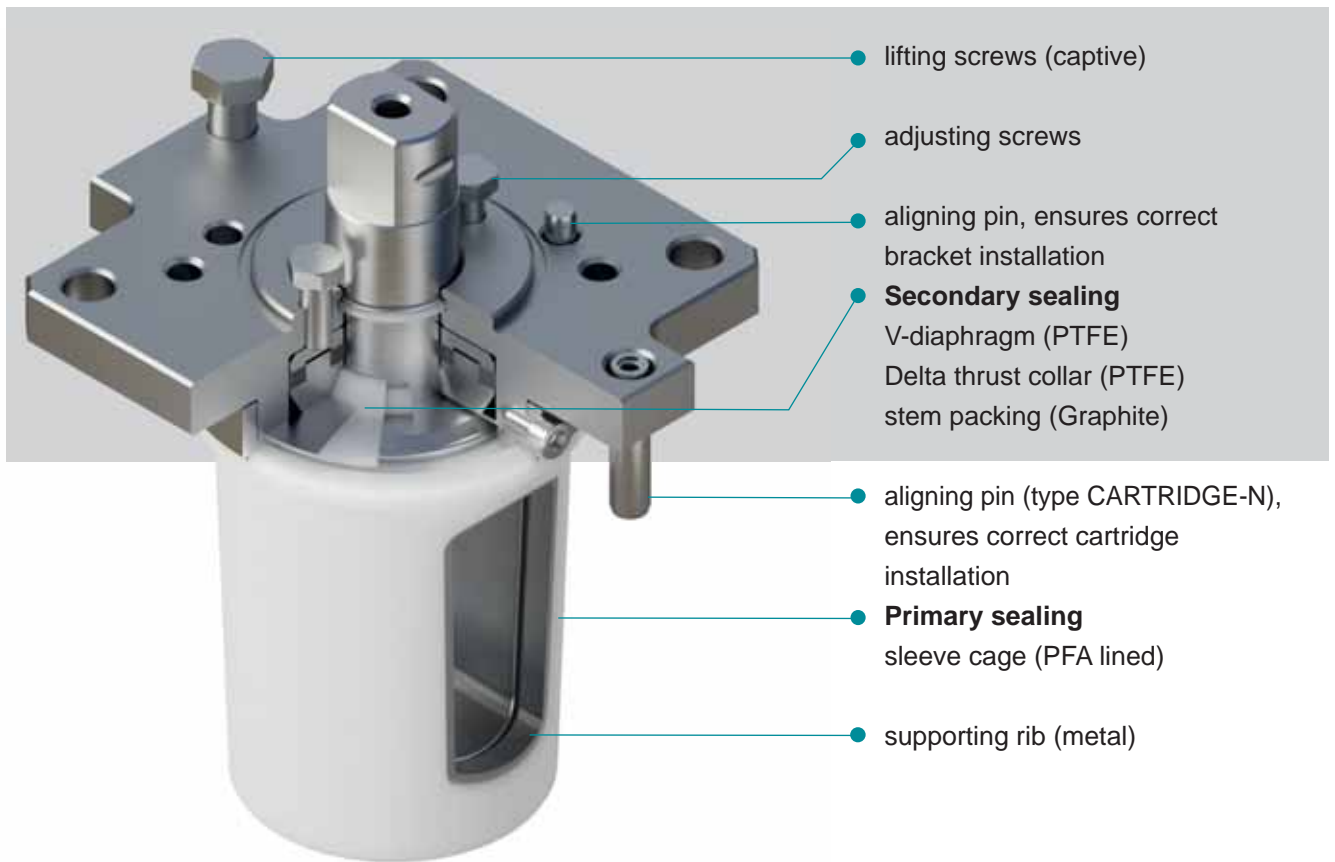

# Type CARTRIDGE

## Technical information

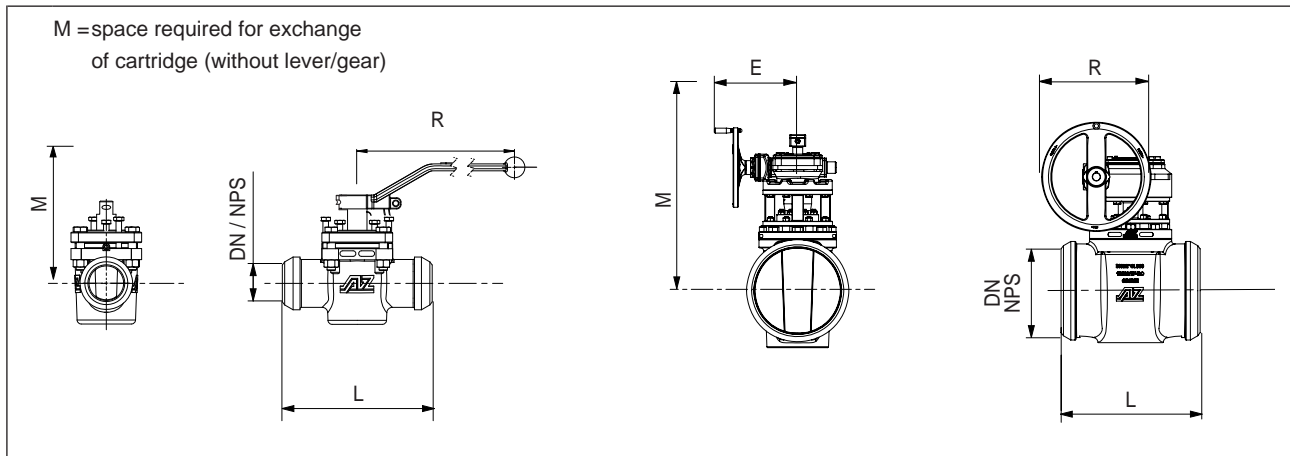

### Type CARTRIDGE

EN / ASME	DN	NPS	L [mm]	M [mm]	E [mm]	R [mm]
	25	1	165	230	-	420
	40	1½	190	230	-	420
	50	2	216	230	-	420
	80	3	282	280	290	400
	100	4	305	*	290	400
	150	6	403 / 457	*	290	400

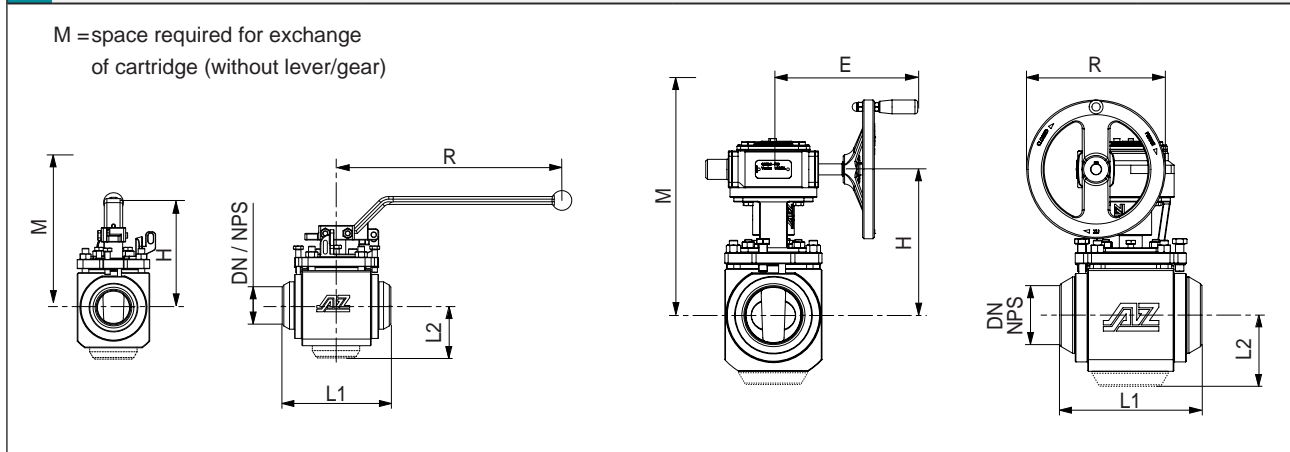

### Type CARTRIDGE-N

EN / ASME	DN	NPS	L1 [mm]	L2 [mm]	M [mm]	R [mm]	E [mm]	I [mm]
	25	1	150	65	230	420	-	-
	40	1½	160	75	230	420	-	-
	50	2	165	89	230	420	-	-
	80	3	205	113	280	-	208	200
	100	4	257	127	*	-	*	200
	150	6	300	159	*	-	*	200

\*) on request

\*\*) dimensions acc. to EN 12627 / EN 12982 (max. PN 100), ASME B16.10 / B16.25 Schedule No 40 (max 600 lbs)

# AZ-plug valve: the design principle

## Key advantages

- free of cavities
- no contamination of process media
- adjustability of the plug and sealings
- maintenance-free due to self-lubricating and chemical-resistant PTFE-sleeve
- low emission design
- constant torque ( $\Delta p$  independent !)
- vacuum-capable

## Tapered plug

- plug pressed into the PTFE-sleeve
- polished surface



## Body

- tapered body interior
- integrated supporting ribs avoid rotation and coldflow of the sleeve
- large sealing surface



## PTFE-sleeve

- mechanically locked into the valve body
- complete PTFE chambering
- robust, one-piece sleeve covers and protects the entire plug



# Cavity-free: suitable for all media

## Technical comparison

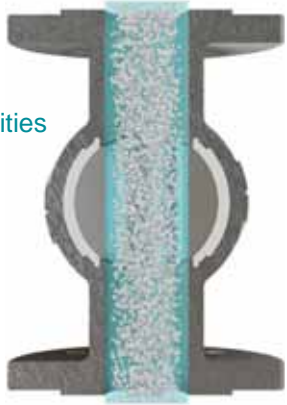
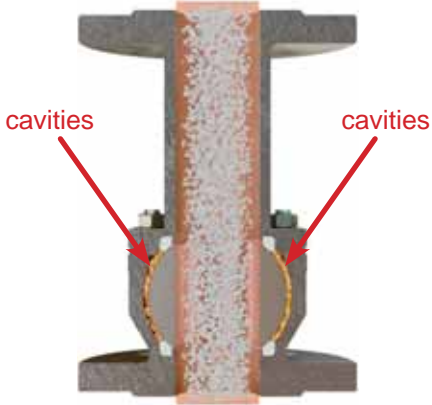
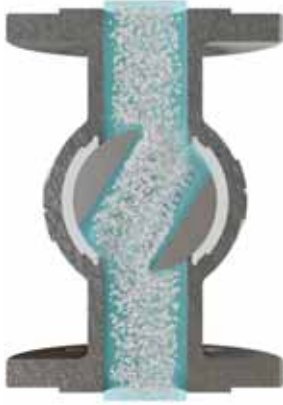
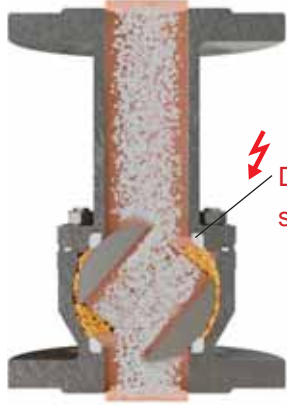
AZ-plug valve	Ball valve
<p><b>Soft seated plug valve with PTFE-sleeve</b></p>  <p><b>Main sealing components</b></p> <ul style="list-style-type: none"> <li>• metallic plug</li> <li>• sleeve</li> </ul>	<p><b>Soft seated ball valve with PTFE sealing rings, floating ball</b></p>  <p><b>Main sealing components</b></p> <ul style="list-style-type: none"> <li>• metallic ball</li> <li>• sealing rings</li> </ul>
OPEN position	
<ul style="list-style-type: none"> <li>• suitable for all media due to cavity-free design</li> <li>• sealing surfaces are completely protected</li> </ul>  <p>free of cavities</p>	<ul style="list-style-type: none"> <li>• critical for the following media due to design with cavities <ul style="list-style-type: none"> <li>○ corrosives: crevice corrosion</li> <li>○ polymerizing: clogging</li> <li>○ crystallizing: abrasion / clogging</li> </ul> </li> </ul>  <p>cavities</p> <p>cavities</p>
During operation	
<ul style="list-style-type: none"> <li>• free of cavities, media cannot settle or be trapped</li> <li>• solids are pushed away</li> <li>• no contamination with old media</li> </ul> 	<ul style="list-style-type: none"> <li>• with cavities, media can settle or be trapped</li> <li>• solids cause abrasion of the sealing rings</li> <li>• contamination of process media</li> </ul>  <p>Damage of the sealing rings</p>

# Safe and reliable tightness for years

## Adjustable



- tapered plug design allows retightening of the sealing on site - if needed
- adjusting bolt even accessible with mounted actuator / gearbox

## Several sealings to atmosphere

- 1 Primary: sleeve
- 2 Secondary: V-diaphragm/cover seal
- 3 Tertiary: stem packing (optional)



Detailed information about all certified AZ cover & stem sealing systems see chapter SEALING SYSTEMS

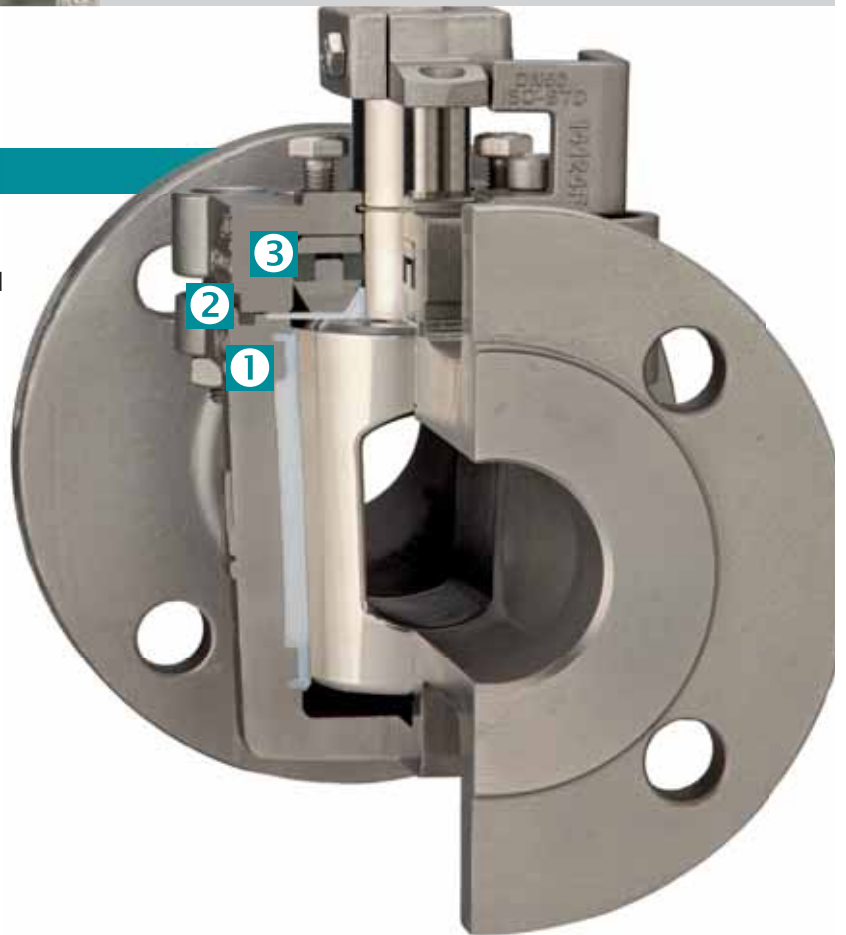

## ISO cover



- pressure containing cover bolts separated from bracket boltings
- cover and bracket acc. to ISO 5211 for efficient actuator / gearbox assembly

# Reduced and full bore design

## Execution

### Reduced bore

#### Type STANDARD

- compact valve (FF / weight)
- optimal torques for economic automation

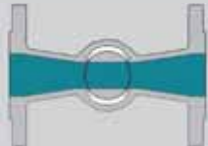

### Full round bore

#### Type EXTRA

- maximum flow rate
- minimal pressure drop
- piggable (optional)

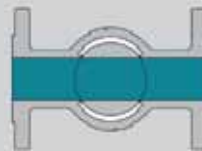

## Type ISO-EXTRA

- excellent for abrasive, slurry and solid-containing applications
- maximum flow rate compared to other valve types with the same nominal size



## Maximum flow rate

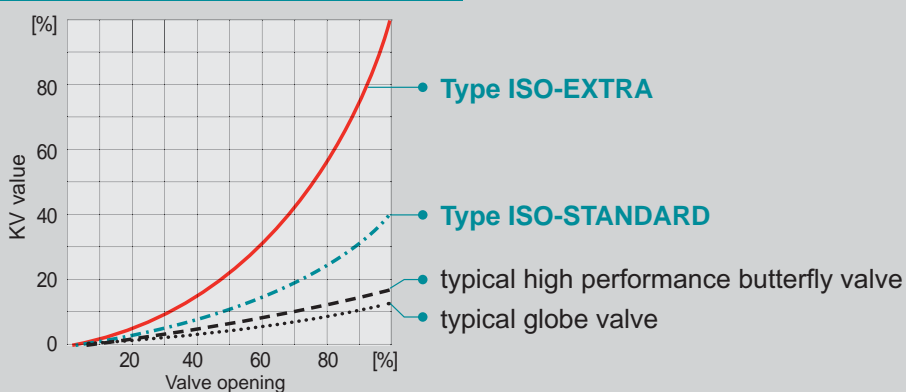

# Options



## Multi-port

- whole range of multi-port plugs for all configurations (up to 7-way)
- horizontal and vertical installation



## Vented options

- plug bottom
- plug upstream / downstream automatic pressure balance in case of thermal media expansion



## System requirements

- **FDA** = Food and Drug Administration certifications and compliant materials
- **GMP** = Good-Manufacturing-Practice
- **CIP** = Clean-in-Place
- Polished internal surfaces, surface finish <math><0.8 \text{ Ra } \mu\text{m}</math> (<math><32 \text{ Ra } \mu\text{in}</math>)
- oil and grease free
- water-free



## All connections possible

- flanges acc. to DIN, ASME, JIS etc.
- welded ends
- screwed and threaded ends
- combinations of connections
- oversize flanges
- compression fittings and ferrule ring couplings
- special connections



## High and low temperature

- extended bonnet with sealing at the top
- stem extension for insulated valves



# Modular operation concept

## Bracket according to ISO 5211

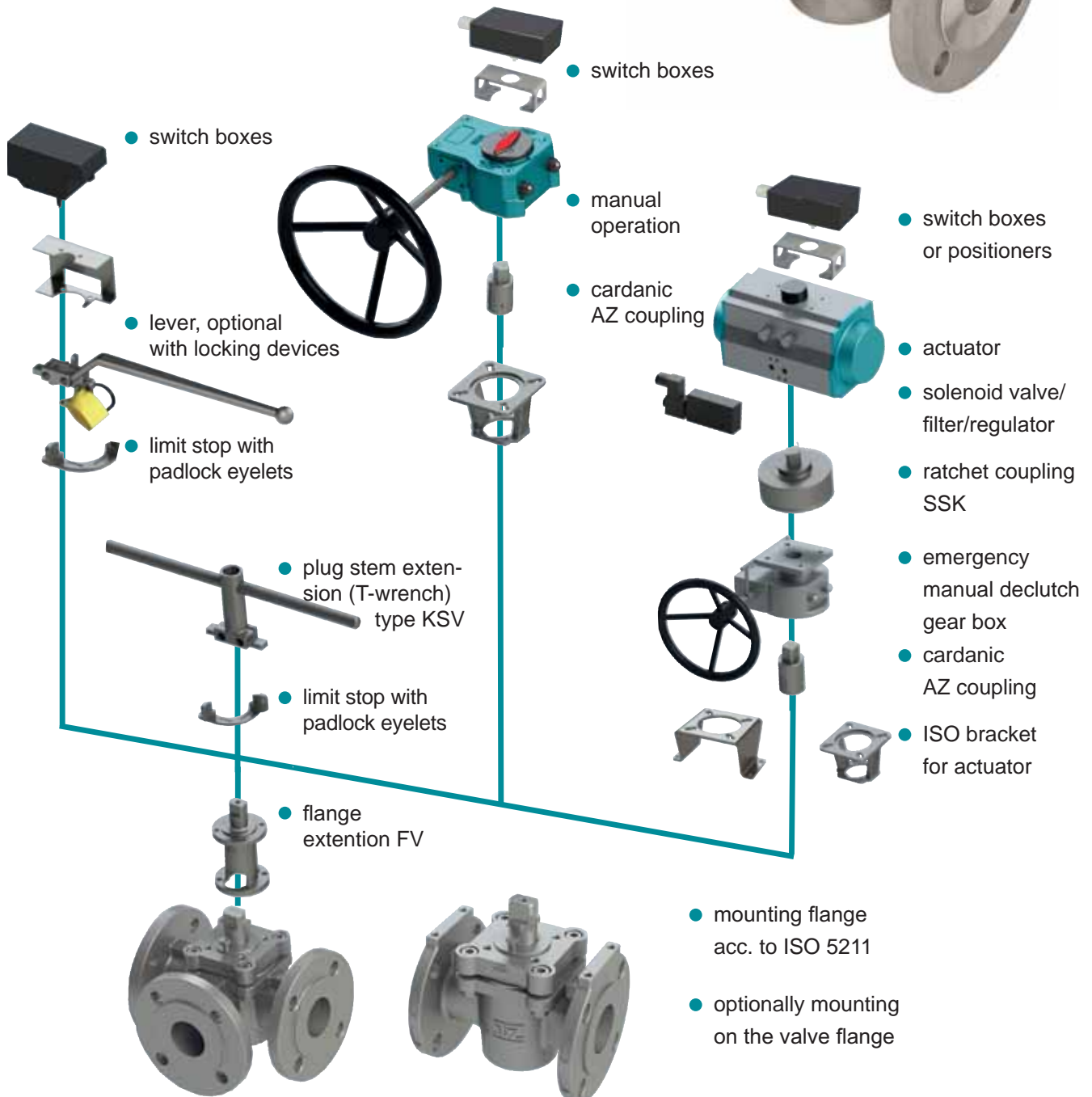
- standard installation of gearbox and actuator
- safe due to independent mounting of cover and bracket
- covering bonnet bolts to prevent opening of valve in service
- precise centering of the bracket to the plug stem due to adjusting ring
- easy inline plug adjustment during the process, screws are always accessible



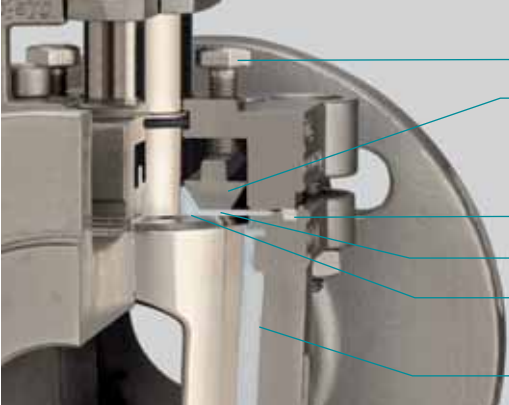

# Cover and stem sealing systems suitable for general applications

Type STANDARD	
	● plug adjustment
	● thrust collar
	● cover sealing (PTFE)
	● stainless steel diaphragm
	● <b>Secondary sealing:</b> V-diaphragm (PTFE), delta thrust collar (PTFE)
	● <b>Primary sealing:</b> sleeve*
Type FS2	
	<b>NEW!</b>
	● plug & packing adjustment
	● <b>Tertiary sealing:</b> Packing to atmosphere (graphite)
	● thrust collar
	● cover sealing (graphite)
	● stainless steel diaphragm
	● <b>Secondary sealing:</b> V-diaphragm (PTFE) and delta thrust collar (PTFE)
	● <b>Primary sealing:</b> sleeve*
Fire-Safe-sealing (API 607)	
Type CA2	
	<b>NEW!</b>
	● plug & packing adjustment
	● <b>Tertiary sealing:</b> Packing to atmosphere (PTFE)
	● thrust collar
	● cover sealing (PTFE)
	● stainless steel diaphragm
	● <b>Secondary sealing:</b> V-diaphragm, delta thrust collar (PTFE)
	● <b>Primary sealing:</b> sleeve*
Chemistry sealing	

\*) The sleeve material has a decisive influence on the maximum operating temperature  
Material selection acc. to PT-diagram

# More safety for severe applications

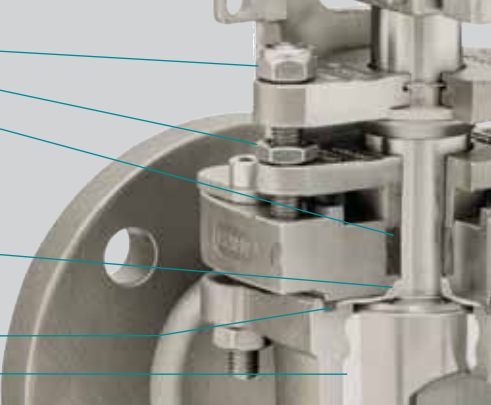
*engineered.  
fast.  
dynamic.*

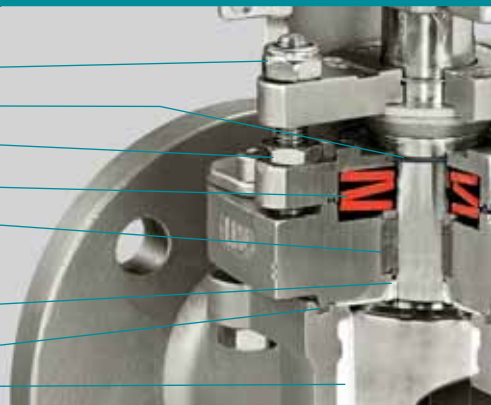
Type FSN	Fire-Safe-sealing (API 607)
<p>plug adjustment</p> <p>triple safety stem packing adjustment</p> <p><b>Tertiary sealing:</b> triple safety stem packing (graphite)</p> <p><b>Secondary sealing:</b> V-diaphragm (PTFE) and delta thrust collar (PTFE)</p> <p>cover sealing (graphite)</p> <p><b>Primary sealing:</b> sleeve*</p>	
<p>Type FSN-EF</p> <p><b>Emission Free</b></p> <p>plug adjustment</p> <p>triple safety stem packing adjustment</p> <p><b>Quaternary sealing:</b> three o-rings at the stem</p> <p><b>Tertiary sealing:</b> triple safety stem packing</p> <p><b>Secondary sealing:</b> V-diaphragm (PTFE) and delta thrust collar (PTFE)</p> <p>cover sealing (graphite)</p> <p><b>Primary sealing:</b> sleeve*</p>	<p><b>NEW!</b></p> 
<p>Type FSN-SL</p> <p><b>live-loaded</b></p> <p>plug adjustment</p> <p>o-rings protect the springs against corrosion</p> <p>triple safety stem packing adjustment</p> <p>disk springs (optionally made of Inconel)</p> <p><b>Tertiary sealing:</b> triple safety stem packing (graphite)</p> <p><b>Secondary sealing:</b> V-diaphragm (PTFE) and delta thrust collar (PTFE)</p> <p>cover sealing (graphite)</p> <p><b>Primary sealing:</b> sleeve*</p>	

\*) The sleeve material has a decisive influence on the maximum operating temperature  
Material selection acc. to PT-diagram

Material for **type CASN** and **CASN-SL** chemistry safety sealing: packing and cover sealing in PTFE

# Special sealing systems

## Chevron packing

- increases the contact pressure (when pressure builds up on the safety stem packing towards plug stem)
- for toxic and fugitive media
- high wear resistance



## Type CL Chlorine / gas applications

- approved for chlorine applications and other toxic gases
- ideal for media with changing state of aggregate (e.g. liquid to gas, vice versa)
- vacuum capable



## Detection ports for monitoring purpose of lethal gases (phosgene, etc.)

- detection ports for early recognition of potential leakages
- sniffing at sealing surfaces to atmosphere

- stem packing
- cover sealing
- flange sealing



# Cover and stem sealing systems for lined plug valves

*engineered.  
fast.  
dynamic.*

Type CA 2A	Chemistry sealing	
<p><b>NEW!</b></p>	<ul style="list-style-type: none"> <li>plug &amp; packing adjustment</li> <li>stem O-ring</li> <li><b>Tertiary sealing:</b> O-ring (FKM / FFKM)</li> <li>thrust collar</li> <li>stainless steel diaphragm</li> </ul>	
	<ul style="list-style-type: none"> <li><b>Secondary sealing:</b> V-diaphragm &amp; delta thrust collar (PTFE)</li> </ul>	
	<ul style="list-style-type: none"> <li><b>Primary sealing:</b> lined body</li> </ul>	
	<ul style="list-style-type: none"> <li>plug adjustment</li> <li>triple safety stem packing adjustment</li> </ul>	
	<ul style="list-style-type: none"> <li><b>Tertiary sealing:</b> triple safety stem packing (PTFE) to atmosphere</li> </ul>	
	<ul style="list-style-type: none"> <li><b>Secondary sealing:</b> V-diaphragm (PTFE), delta thrust collar (PTFE)</li> </ul>	
<ul style="list-style-type: none"> <li>lined cover</li> <li><b>Primary sealing:</b> lined body*</li> </ul>		
Type SAFE-LINED	Chemistry sealing	
<p><b>lined cover</b></p>	<ul style="list-style-type: none"> <li>plug adjustment</li> <li>triple safety stem packing adjustment</li> </ul>	
	<ul style="list-style-type: none"> <li><b>Tertiary sealing:</b> triple safety stem packing (PTFE) to atmosphere</li> </ul>	
	<ul style="list-style-type: none"> <li><b>Secondary sealing:</b> V-diaphragm (PTFE), delta thrust collar (PTFE)</li> </ul>	
	<ul style="list-style-type: none"> <li>lined cover</li> <li><b>Primary sealing:</b> lined body*</li> </ul>	
	Type SAFE-LINED-SL	Chemistry sealing
	<p><b>live-loaded</b></p>	<ul style="list-style-type: none"> <li>plug adjustment</li> <li>o-rings protect the springs against corrosion</li> <li>triple safety stem packing adjustment</li> <li>disk springs (optionally made of Inconel)</li> </ul>
<ul style="list-style-type: none"> <li><b>Tertiary sealing:</b> triple safety stem packing (PTFE) to atmosphere</li> </ul>		
<ul style="list-style-type: none"> <li><b>Secondary sealing:</b> V-diaphragm (PTFE), delta thrust collar (PTFE)</li> </ul>		
<ul style="list-style-type: none"> <li>lined cover</li> <li><b>Primary sealing:</b> lined body*</li> </ul>		

\*) Lining and plug material have a decisive influence on the maximum operating temperature  
Material selection according to PT-diagram.

**WORLD'S FIRST EMISSION FREE**  
plug valve certified acc. to **ISO 15848-1 / AH**  
Type **FSN-EF**

**NEW!**



Fugitive  
Emissions



# Low-Emission according ISO 15848, TA-Luft & API 641



For all important information about ISO 15848, TA-Luft & API 641, as well as the current certificates, please refer to the "AZ Fugitive Emission" brochure



Latest information about ISO 15848 / API 641 / TA Luft see AZ Fugitive Emissions leaflet



# Casting materials



Material Group	Common Name	Casting Material					
		EN / DIN	Short name	Material-No.	ASTM	Grade	UNS
<b>Carbon Steel / Ductile Iron</b>							
Ductile Iron	SG Iron	EN 1563	EN-GJS-400-18-LT	5.3103	A395	-	F32800
Carbon Steel	CS	EN 10213	GP240GH	1.0619	A216	WCB	J03002
Low Temp. Carbon Steel	LTCS	EN 10213	G17Mn5	1.1131	A352	LCB	J03003
Low Temp. Carbon Steel	LTCS	EN 10213	G21Mn5	1.1138	A352	LCC	J02505
<b>Stainless Steel</b>							
Stainless Steel	Duplex 2205	EN 10213	GX2CrNiMoN22-5-3(4A)	1.4470	A995	4A-CD3MN	J92205
Stainless Steel	Duplex 1B	EN 10213	GX3NiCrMoCuN26-6-3-3	1.4517	A995	1B-CD4MCuN	J93372
Austenitic	SS	EN 10213	GX5CrNi19-10	1.4308	A351	CF8	J92600
Austenitic	SS	EN 10213	GX2CrNi19-11	1.4309	A351L	CF3	J92700
Austenitic	SS	EN 10213	GX5CrNiMo19-11-2	1.4408	A351	CF8M	J92900
Austenitic	SS	EN 10213	GX2CrNiMo19-11-2	1.4409	A351	CF3M	J92800
Super Austenitic	Alloy 20	EN 10213	NiC420CuMo	1.4500	A351	CN7M	N08007
Super Austenitic	Alloy 20 mod.	EN 10213	GX2NiCrMoCuN25-20	1.4536	A743	CN7MS	J94650
Super Austenitic	AL6XN	-	-	-	A351	CN3MN	J94651
Superduplex	Superduplex 5A	EN 10213	25Cr-7Ni-Mo-N	1.4469	A995	CE3MN	J93404
<b>Nickel Alloy</b>							
	Monel/Alloy400	DIN 17730	G-NiCu30 Nb	2.4365	A494	M35-1	N24135
	Hastelloy C mod.	-	-	-	A494	CW6M	N30107
	Hastelloy C	-	-	2.4537	A494	CW12MW	N30002
	Hastelloy C-276	-	-	2.4883	-	-	-
	Hastelloy B-3	-	-	-	-	-	-
	Inconel 600	-	-	-	A494	CY40	N06040
	Inconel 625	-	-	-	A494	CW6MC	N26625
	Inconel 825	-	-	-	A494	CU5MCuC	N08826
	Nickel	DIN 17730	G-Ni 95	2.4170	A494	CZ100	N02100
<b>Other Material Groups</b>							
Tantalum	Tantalum	-	-	-	-	-	-
Titanium	Ti 2	DIN 17865	G-Ti 2	3.7031	B367	C-2	R52550
Zirconium	Zirconium 702	-	-	-	B752	702C	-
Zirconium	Zirconium 705	-	-	-	-	705C	-

All rights reserved, all indications without engagement, subject to modifications.

The use of these equivalents has to be evaluated on a case-by-case basis.

Other materials on request.

# Equivalent forged and bar-stock materials



Common Name	Mat.Nr.	Grade	Similar Forged Material						Bar Material	
			EN / DIN	Short Name	Mat.Nr.	ASTM	Grade	UNS	ASTM Short	
<b>Carbon Steel / Ductile Iron</b>										
SG Iron	5.3103	-	EN 1563	EN-GJS-400-18-LT	5.3103	A395-99	60-40-18	-	-	-
CS	1.0619	WCB	EN 10213	GP240GH	1.0619	A105	A105	-	-	-
LTCS	1.1131	LCB	-	-	-	A350	LF2-Class1	G10300	-	-
LTCS	1.1138	LCC	-	-	1.0566	A350	LF2-Class1	G10250	-	-
<b>Stainless Steel</b>										
Duplex 2205	1.4470	4A-CD3MN	EN 10028-7	X2CrNiMoN22-5-3	1.4462	A182	F51	S32205	A479	S31803
Duplex 1B	1.4517	1B-CD4MCuN	EN 10028-7	X2CrNiMoCuN25-5-3	1.4507	A182	F59	S32520	A479	S32550
SS	1.4308	CF8	EN 10028-7	X5CrNi18-10	1.4301	A182	F304	S30400	A276	304
SS	1.4309	CF3	EN 10028-7	X2CrNi19-11	1.4306	A182	F304L	S30403	A276	304L
SS	1.4408	CF8M	EN 10028-7	X5C4NiMo17-12-2	1.4401	A182	F316	S31600	A276	316
SS	1.4409	CF3M	EN 10028-7	X2CrNiMo 17-12	1.4404	A182	316L	S31603	A276	316L
Alloy 20	1.4500	CN7M	-	-	2.4660	B462	N08020	N08020	B473	N08020
Alloy 20 mod.	1.4536	CN7MS	-	-	-	-	-	-	-	-
AL6XN	-	CN3MN	EN 10028-7	X1NiCrMoCuN25-20-7	1.4529	A182	F62	N08367	B462	N08367
Superduplex 5A	1.4469	CE3MN	EN 10028-7	X2CrNiMoN25-7-4	1.4410	A182	F63	S32615	-	-
<b>Nickel Alloy</b>										
Monel/Alloy400	2.4365	M35-1	DN 17744	NiCu30Fe	2.4360	B165	Alloy 400	N04400	B164	N04400
Hastelloy C mod.	-	CW6M	-	-	-	A494	-	-	-	-
Hastelloy C	-	CW12MW	-	NiMo16CrW	-	A494	-	-	-	-
Hastelloy C-276	-	-	DIN 17744	NiMo16Cr15W	2.4819	B565	N10675	N10276	B574	N10276
Hastelloy B-3	-	-	DIN 17744	NiMo29Cr	2.4600	B565	N10675	N10675	B335	N10675
Inconel 600	-	CY40	DIN 17742	NiCr15Fe	2.4816	B565	N06600	N06600	B166	N06600
Inconel 625	-	CW6MC	DIN 17744	NiCr22Mo9Nb	2.4856	B565	N06625	N06625	B446	N06625
Inconel 825	-	CU5MCuC	DIN 17744	NiCr21Mo	2.4858	B564	N08825	N08825	B425	N08825
Nickel	2.4170	CZ100	-	-	-	-	-	-	B160	N02200
<b>Other Material Groups</b>										
Tantalum	-	-	-	-	-	B365	TaW2,5	R05252	-	-
Ti 2	3.7031	C-2	DIN 17864	Grade 2	3.7035	B381	F2	R50400	B348	Grade 2
Zirconium 702	-	702C	-	-	6.0702	B493	R60702	R60702	B550	R60702
Zirconium 705	-	705C	-	-	-	B493	R60705	R60705	B550	R60705

All rights reserved, all indications without engagement, subject to modifications.

The use of these equivalents has to be evaluated on a case-by-case basis.

Other materials on request.

# Lining materials



## Lining materials

The high density, extremely resistant lining is at least 3 mm thick. New granulate is used exclusively, no refurbished regenerates or similar materials.

## Fluoropolymer lining materials

- Body: PFA, PFA conductive and FEP
- Plug: PTFE, PFA, PFA conductive and FEP

body lining	Combination of linings plug lining	T <sub>max</sub>
PFA	PTFE <sup>1)</sup> or special materials	210°C / 410°F
PFA	PFA	200°C / 392°F
PFA	FEP	150°C / 302°F
PFA conductive	PFA conductive	125°C / 257°F
FEP	FEP	150°C / 302°F
FEP	PFA	150°C / 302°F

- 1) Plugs with PTFE lining only for two-way valves up to DN 100.  
Plugs for multi-way valves not with PTFE lining available.

## IMPORTANT NOTE

For demanding conditions, such as process temperatures exceeding 150°C / 302°F: Valve size, media phase, plug position & temperature (constant or fluctuating) may have an impact on the lifetime. Consult factory for proper selection of lining material, cover sealing type and special features.

# Sleeve materials



Category	Sleeve Material	Characteristics	Typical applications	T <sub>MAX</sub>
PTFE	PTFE, virgin	low friction, very good sealing characteristic	standard sleeve material for most applications	230°C / 446°F
RPTFE	PTFE-Glass	reinforced PTFE	additional stability for multiway valves with horizontal ports	230°C / 446°F
	PTFE-Graphite	reinforced PTFE	high temperature applications	250°C / 482°F
modified PTFE	TFM 1600* NXT 75* M 111*	chemically modified PTFE, reduced permeation, low friction	chemical applications where reduced permeability compared to PTFE is required	250°C / 482°F
Special Sleeves	PTFE-P* NFCE* NCS*	high performance sleeve materials	severe service highest temperatures, high pressure, abrasive applications	320°C / 608°F
PFA	PFA	reduced permeation	chemical applications where reduced permeability compared to PTFE is required	200°C / 392°F
UHMW-PE	UHMW-PE	Ultra High Molecular Weight Polyethylene	radiation resistant, abrasive application	80°C / 176°F

\*) sleeve material selection depending on availability at AZ manufacturing site

## IMPORTANT NOTE

for demanding conditions, such as process temperatures exceeding 200°C / 392°F:  
Valve size, media phase, plug position & temperature (constant or fluctuating) may have an impact on the lifetime. Consult factory for proper selection of sleeve material, cover sealing type and special features. For other sleeve materials not listed above: please contact your AZ sales representative.

# PT Diagram, PN 16 - PN 100

## PTFE sleeved plug valves

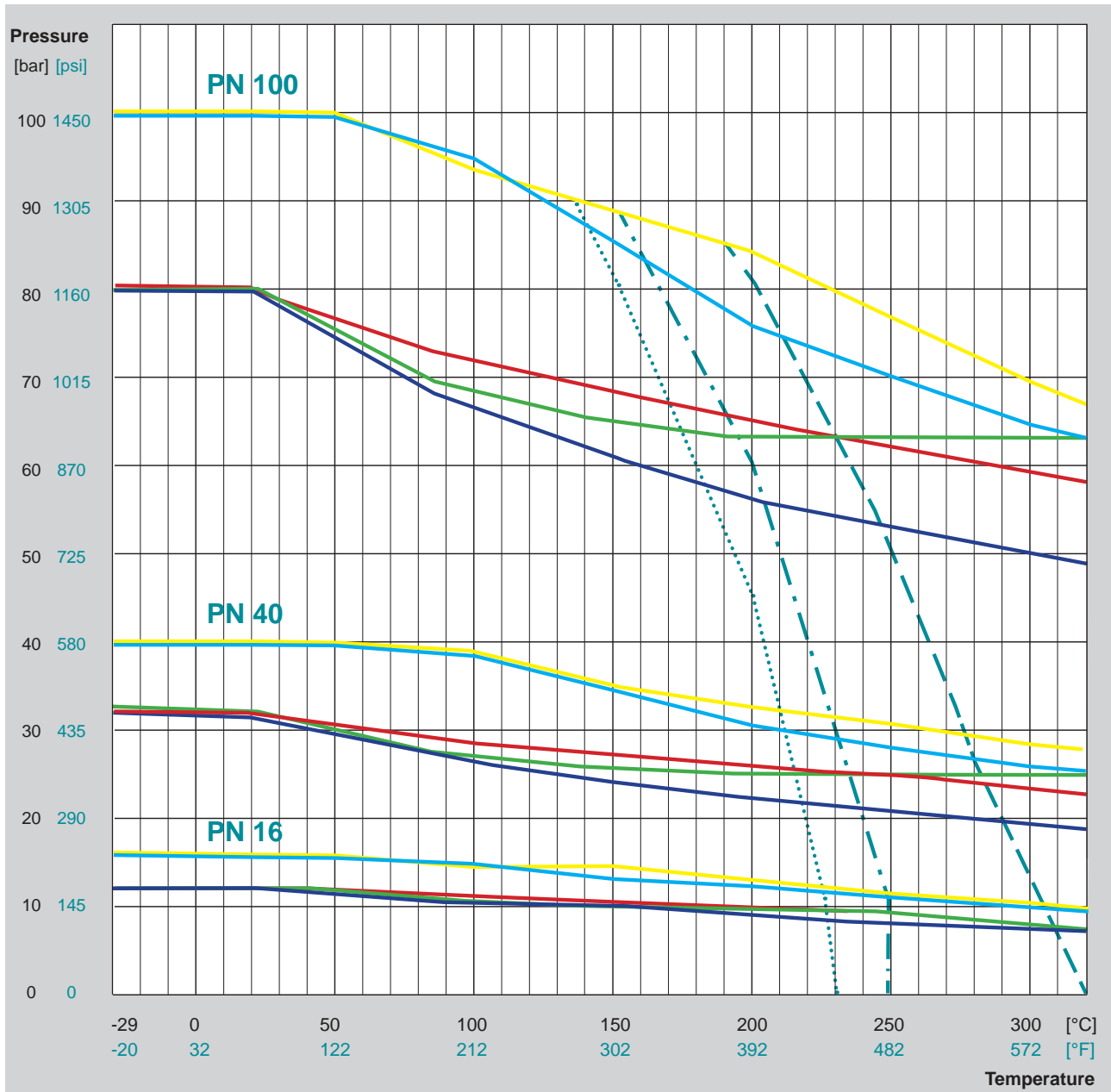

### Body material

- EN 10213 - 1.0619 / Carbon Steel
  - EN 10213 - 1.4408 / Stainless Steel
  - EN 17744 - 2.4819 / Hastelloy
  - EN 17730 - 2.4365 / Monel 400
  - UNS N08007 - 1.4500 / Alloy 20
- other body materials on request

### Sleeve material

- ..... PTFE (virgin) / PTFE (glass)  $T_{max}$  230°C / 446°F
  - .-.-.- TFM / NXT / M111 / PTFE graphite  $T_{max}$  250°C / 482°F
  - PTFE-P / NFCE / NCS  $T_{max}$  320°C / 608°F
- other sleeve materials on request

The data given are max. values according to EN 12516-1 and EN 1092-1.

### IMPORTANT NOTE

for demanding conditions, such as process temperatures exceeding 200°C / 392°F: Valve size, media phase, plug position & temperature (constant or fluctuating) may have an impact on the lifetime. Consult factory for proper selection of sleeve material, cover sealing type and special features.

For temperatures < -29°C / -20°F, ( $T_{limit} = -60°C / -76°F$ ) operating temperature, low-temperature carbon steel or austenitic stainless steels are required.

Subject to technical change without notice.

# PT Diagram, Class 150 - Class 600

## PTFE sleeved plug valves

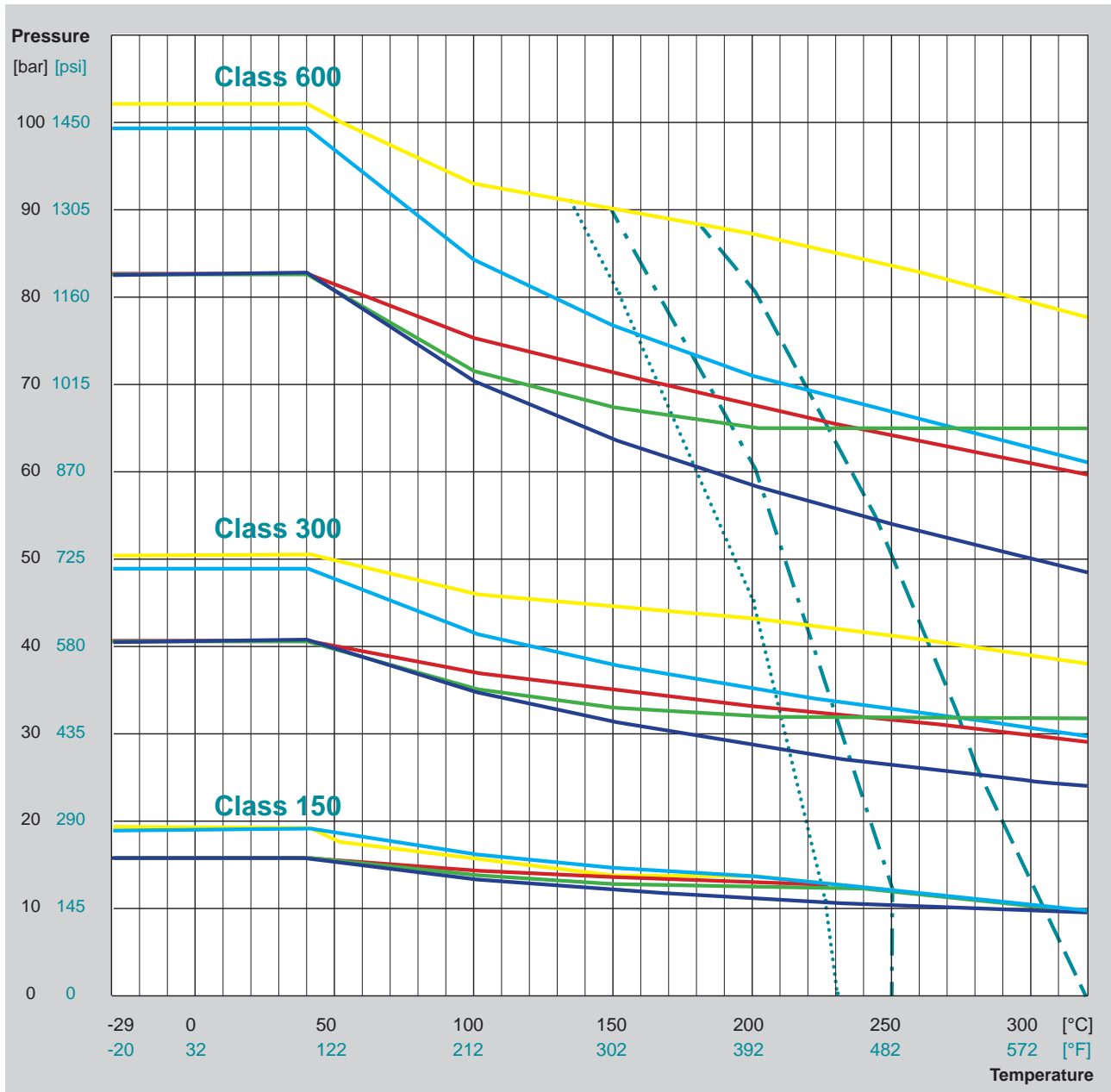

### Body material

- ASTM A216 - WCB
- ASTM A351 - CF8M
- ASTM A494 - CW12MW / Hastelloy
- ASTM A494 - M35.1 / Monel 400
- ASTM A351 - CN7M Alloy 20
- other body materials on request

### Sleeve material

- - - - - PTFE (virgin) / PTFE (glass)  $T_{max}$  230°C / 446°F
- . - . - TFM / NXT / M111 / PTFE graphite  $T_{max}$  250°C / 482°F
- - - - - PTFE-P / NFCE / NCS  $T_{max}$  320°C / 608°F
- other sleeve materials on request

The data given are max. values according to ASME B16.34.

### IMPORTANT NOTE

for demanding conditions, such as process temperatures exceeding 200°C / 392°F: Valve size, media phase, plug position & temperature (constant or fluctuating) may have an impact on the lifetime. Consult factory for proper selection of sleeve material, cover sealing type and special features.

For temperatures < -29°C / -20°F, ( $T_{limit} = -60°C / -76°F$ ) operating temperature, low-temperature carbon steel or austenitic stainless steels are required.

Subject to technical change without notice.

# PT Diagram High Pressure, PN 160

## PTFE sleeved plug valves with trunnion mounted design

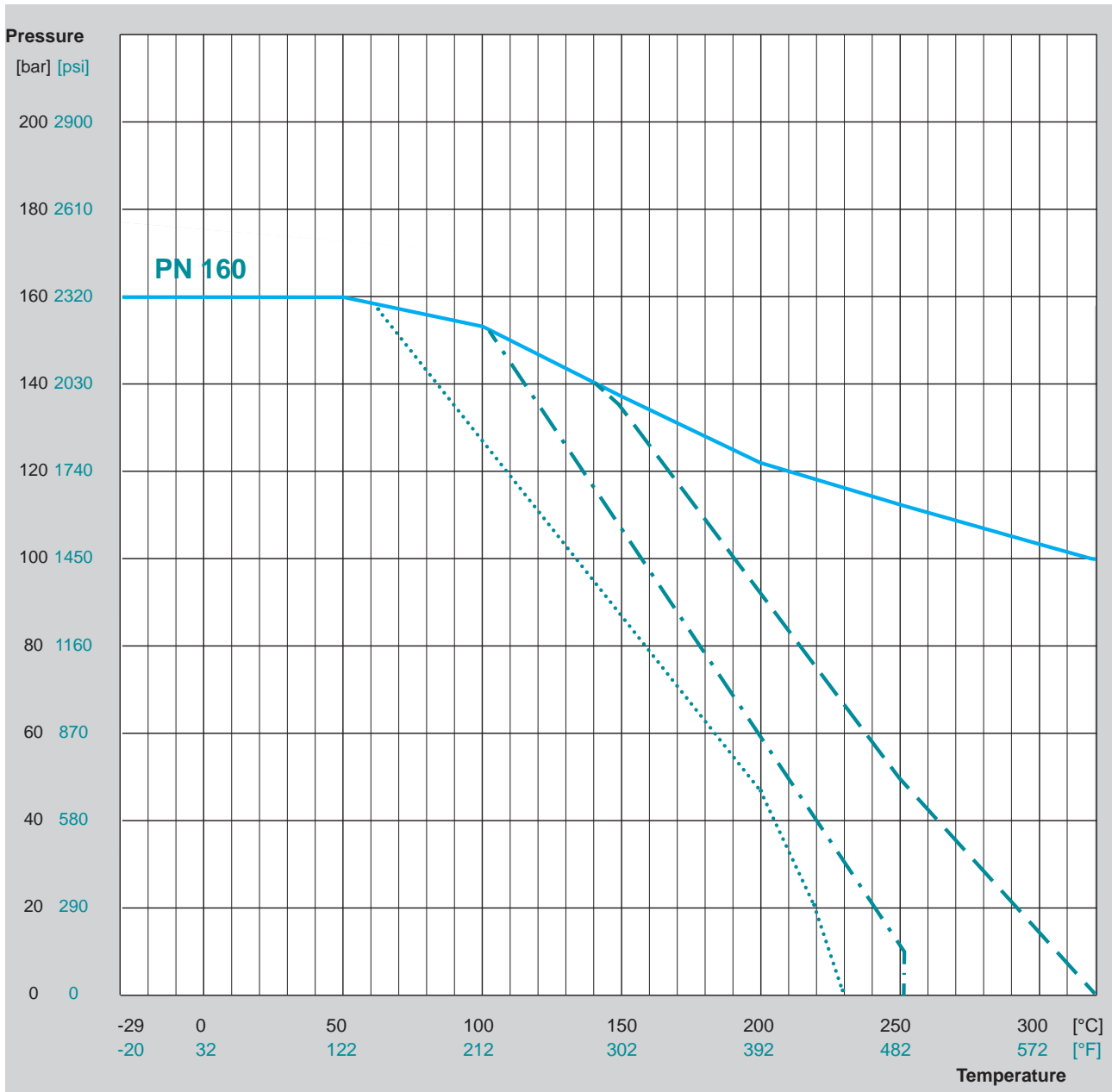

### Body material (in line with EN 12516-1 and EN 1092-1)

- EN 10213 - 1.4408 / Stainless Steel
- other body materials on request

### Sleeve material

- ..... PTFE (virgin) / PTFE (glass)  $T_{max}$  230°C / 446°F
- . - . TFM / NXT / M111 / PTFE graphite  $T_{max}$  250°C / 482°F
- PTFE-P / NFCE / NCS  $T_{max}$  320°C / 608°F
- other sleeve materials on request

The data given are max. values according to EN 12516-1 and EN 1092-1.

### IMPORTANT NOTE

for demanding conditions, such as process temperatures exceeding 200°C / 392°F: Valve size, media phase, plug position & temperature (constant or fluctuating) may have an impact on the lifetime. Consult factory for proper selection of sleeve material, cover sealing type and special features.

For temperatures < -29°C / -20°F, ( $T_{limit} = -60°C / -76°F$ ) operating temperature, low-temperature carbon steel or austenitic stainless steels are required.

Subject to technical change without notice.

# PT Diagram High Pressure, Class 900

## PTFE sleeved plug valves with trunnion mounted design

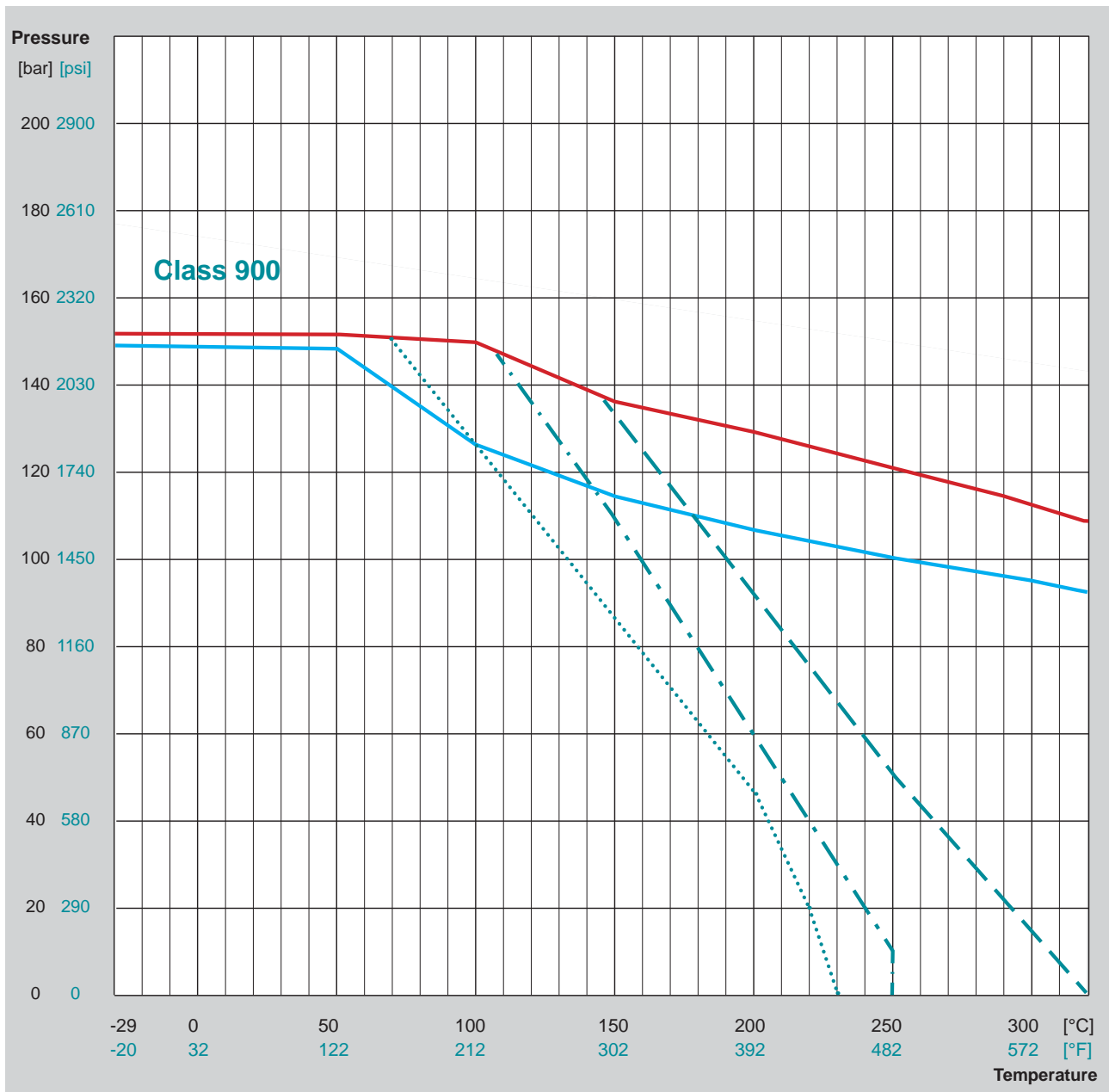

### Body material (in line with ASME B16.34)

- ASTM A351 - CF8M / Stainless Steel
- ASTM A995 - CD3MN / Superduplex
- other body materials on request

### Sleeve material

- ⋯⋯⋯ PTFE (virgin) / PTFE (glass)  $T_{max}$  230°C / 446°F
- · - · - TFM / NXT / M111 / PTFE graphite  $T_{max}$  250°C / 482°F
- - - - - PTFE-P / NFCE / NCS  $T_{max}$  320°C / 608°F
- other sleeve materials on request

The data given are max. values according to ASME B16.34.

### IMPORTANT NOTE

for demanding conditions, such as process temperatures exceeding 200°C / 392°F: Valve size, media phase, plug position & temperature (constant or fluctuating) may have an impact on the lifetime. Consult factory for proper selection of sleeve material, cover sealing type and special features.

Subject to technical change without notice.

For temperatures < -29°C / -20°F, ( $T_{limit} = -60°C / -76°F$ ) operating temperature, low-temperature carbon steel or austenitic stainless steels are required.

# PT Diagram, PN 10 - PN 40 lined valves

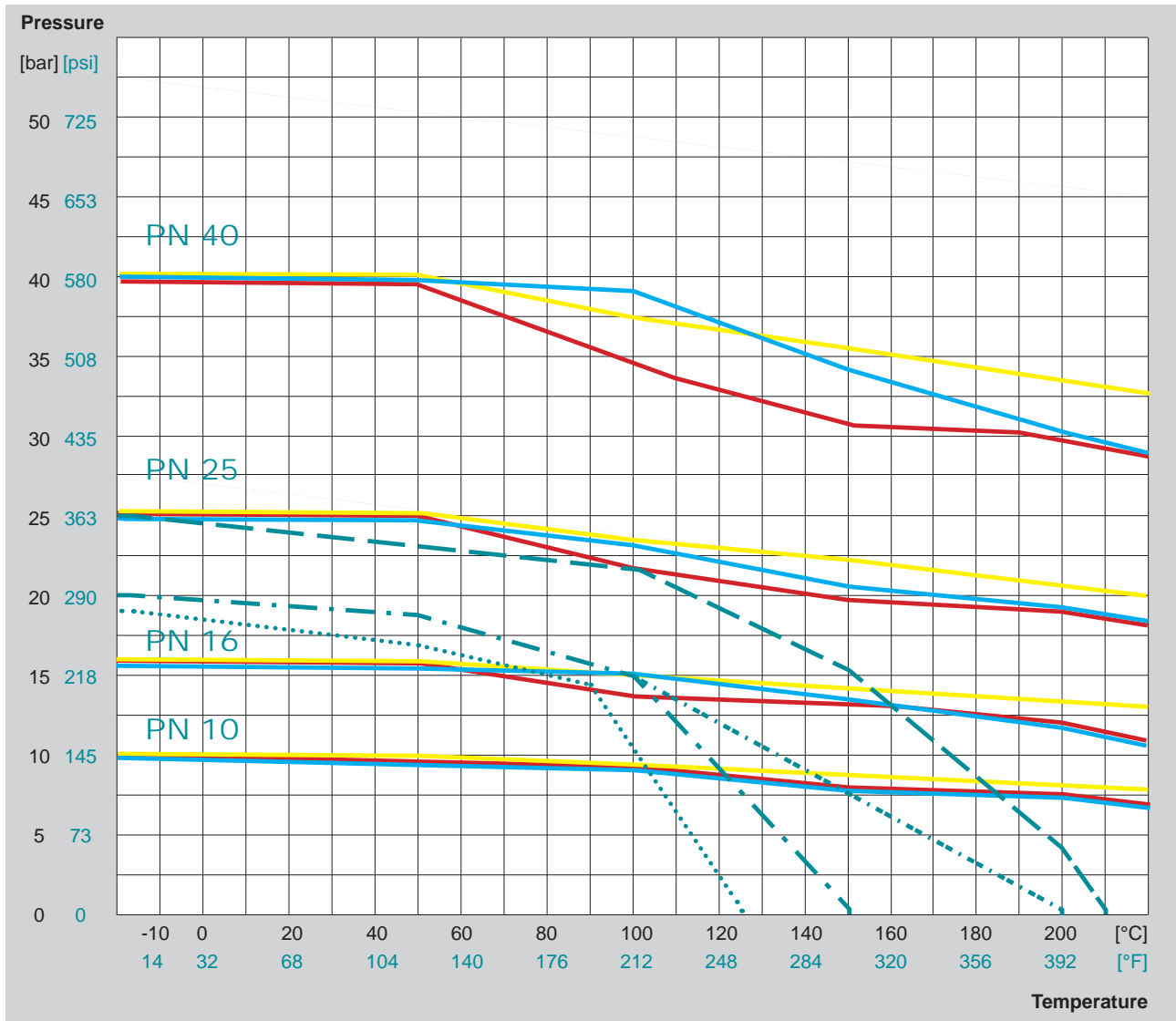

### Body material

- EN 10213 - 1.0619 / Carbon Steel
  - EN 10213 - 1.4408 / Stainless Steel
  - EN 1563 - EN-GJS-400-18-LT / Ductile Iron
- other body materials on request

### Lining combination

	Body	Plug / Ball	T <sub>MAX</sub>
<span style="color: teal;">- - -</span>	PFA	PTFE or special*	210°C / 410°F
<span style="color: teal;">. . . . .</span>	PFA	PFA	200°C / 392°F
<span style="color: teal;">- . . . .</span>	all combinations with PFA and FEP		150°C / 302°F
<span style="color: teal;">. . . . .</span>	PFA conductive	PFA conductive**	125°C / 257°F

\*) Special materials (metallic) for plugs without lining on request

\*\*) Material combination PFA / FEP possible

The data given are max. values according to EN 12516-4.

### IMPORTANT NOTE

for demanding conditions, such as process temperatures exceeding 150°C / 302°F: Valve size, media phase, plug position & temperature (constant or fluctuating) may have an impact on the lifetime. Consult factory for proper selection of lining material, cover sealing type and special features.

Maximum breakaway torque depending on material combinations according to the technical data sheets of the plug valve.

Subject to technical change without notice.

# PT Diagramm, Class 150 - Class 300 lined valves

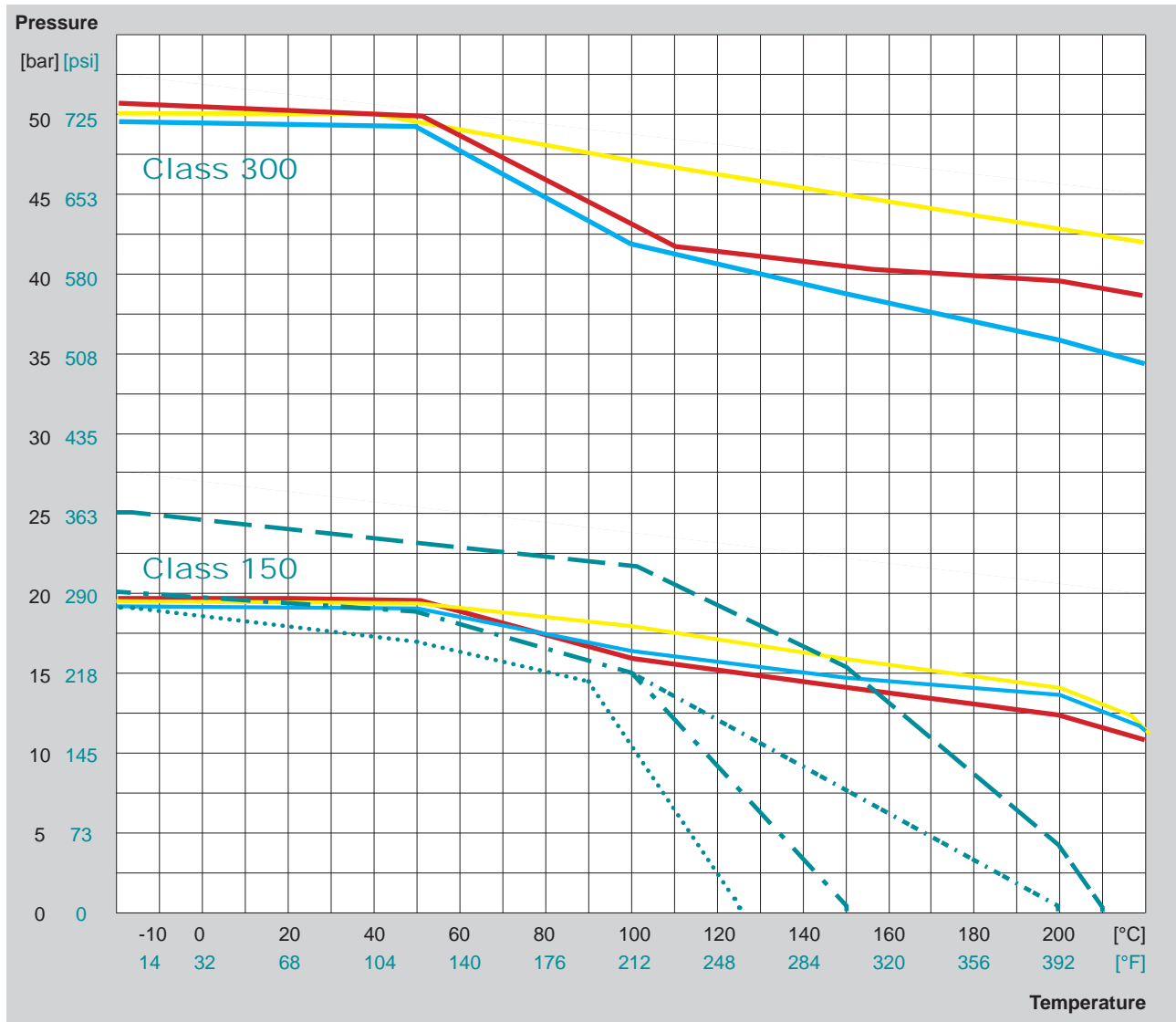

### Body material

- ASTM A216 - WCB
- ASTM A351 - CF8M / Stainless Steel
- ASTM A395 / Ductile Iron
- other body materials on request

### Lining combination

	Body	Plug / Ball	T <sub>MAX</sub>
<span style="color: teal;">- - -</span>	PFA	PTFE or special*	210°C / 410°F
<span style="color: teal;">- · - · -</span>	PFA	PFA	200°C / 392°F
<span style="color: teal;">- · - · - · -</span>	all combinations with PFA and FEP		150°C / 302°F
<span style="color: teal;">· · · · ·</span>	PFA conductive	PFA conductive**	125°C / 257°F

\*) Special materials (metallic) for plugs without lining on request

\*\*) Material combination PFA / FEP possible

The data given are max. values according to ASME B16.34 / B16.42.

### IMPORTANT NOTE

for demanding conditions, such as process temperatures exceeding 150°C / 302°F: Valve size, media phase, plug position & temperature (constant or fluctuating) may have an impact on the lifetime. Consult factory for proper selection of lining material, cover sealing type and special features.

Maximum breakaway torque depending on material combinations according to the technical data sheets of the plug valve.

Subject to technical change without notice.

# Plug types: two-way and multi-port for standard reduced and full bore design



- position indicator for all multi-way valves welded on lever or stem extension
- Lined plug valves: multi-way plugs only with PFA / FEP plug lining or made of special materials. Two-way plugs with PTFE lining up to DN 100 / NPS 4 available

Recommendation for three-way valves type F-3-S with vertical outlet (longer life-time compared to type F-3-W with horizontal outlet)

### Options

Plugs made of special materials or special designs, e.g. with flushing devices, vent holes in plug bottom or plug upstream / downstream side

2-way	Plug type	Pos. I = 0°	Pos. II = 90°	Pos. III = 180°	Pos. IV = 270°
Type F-2-ISO-STANDARD					

\*) For highly expanding media AZ recommends the "i-plug" (relief hole and open plug bottom)

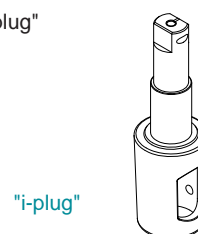

Type F-2-ISO-STANDARD-A

# Plug types: 3-way valve for STANDARD and EXTRA design

Plug type	Pos. I = 0°	Pos. II = 90°	Pos. III = 180°	Pos. IV = 270°	3-way (vertical)
<b>L</b>					 Type F-3-S-ISO-STANDARD   Type F-3-S-ISO-STANDARD-A
<b>LL</b>					
<b>IL*</b>					
<b>TT</b>					

Plug type	Pos. I = 0°	Pos. II = 90°	Pos. III = 180°	Pos. IV = 270°	3-way (horizontal)
<b>T4</b>					 Type F-3-W-ISO-STANDARD   Type F-3-W-ISO-STANDARD-A
<b>L4</b>					

\*) for EXTRA valves with IL-plug, F-3-W-EXTRA with T4-plug is recommended (higher flowrate)  
Lined valves: the IL-plug is only available in special materials

# Plug types 3-way (120°) valves and 4-way valves for STANDARD and EXTRA design

**3-way (120°) type 3-W-120:**

- min. cross section guaranteed (switching phase)
- piggable execution on request
- minimum flow guaranteed

**transflow design**

**3-way (120°) type 3-WP-120**

- with positive overlap
- flow interruption / isolation

**positive overlap**

3-way (120°)	Plug type	Pos. I = 0°	Pos. II = 120°	Pos. III = 240°	
	<b>L120</b> 				

4-way	Plug type	Pos. I = 0°	Pos. II = 90°	Pos. III = 180°	Pos. IV = 270°
 Type F-4-ISO-STANDARD  	<b>L4</b> 				
	<b>T4</b> 				
	<b>LL4</b> 				

open  
 closed

# Plug types 4-way (special) and 5-way valves for STANDARD and EXTRA design

Plug type	Pos. I = 0°	Pos. II = 90°	Pos. III = 180°	Pos. IV = 270°	4-way (special) / 5-way
<b>L</b>	 A, B, C ✓ A-B ✗ C-D-E	 A, B, C ✓ A-E ✗ B-C-D	 A, B, C ✓ A-C ✗ B-D-E	 A, B, C ✓ A-D ✗ B-C-E	 Type F-4-Special-ISO-STANDARD    Type F-5-ISO-STANDARD  
<b>LL</b>	 A, B, C ✓ A-B-E ✗ C-D	 A, B, C ✓ A-C-E ✗ B-D	 A, B, C ✓ A-C-D ✗ B-E	 A, B, C ✓ A-B-D ✗ C-E	
<b>IL</b>	 A, B, C ✓ A-E + B-C ✗ D	 A, B, C ✓ A-C + D-E ✗ B	 A, B, C ✓ A-D + B-C ✗ E	 A, B, C ✓ A-B + D-E ✗ C	
<b>T</b>	 A, B, C ✓ A-B-C ✗ D-E	 A, B, C ✓ A-D-E ✗ B-C	 A, B, C ✓ A-B-C ✗ D-E	 A, B, C ✓ A-D-E ✗ B-C	
<b>TT</b>	 A, B, C ✓ A-B-C-D ✗ E	 A, B, C ✓ A-B-D-E ✗ C	 A, B, C ✓ A-B-C-E ✗ D	 A, B, C ✓ A-C-D-E ✗ B	

✓ open  
 ✗ closed



## AZ plants

### Headquarters Germany

AZ Armaturen GmbH  
Waldstrasse 7  
D-78087 Moenchweiler  
Phone: +49 / 7721 / 7504-0  
sales@az-armaturen.com  
www.az-armaturen.com

### Plant Brazil

AZ Armaturen do Brasil LTDA.  
Av. Osvaldo Berto, 600  
CEP 13255-405 Itatiba - SP  
Phone: +55 / 11 / 452499-50 / -51  
az@az-armaturen.com.br  
www.az-armaturen.com.br

### Plant China

AZ Armaturen (Taicang) Co., Ltd.  
No. 1 Zhengzhou Road  
215400 Taicang City  
Phone: +86 / 512 / 53667600  
info@az-armaturen.cn  
www.az-armaturen.cn

### Plant South Africa

AZ Armaturen South Africa PTY LTD.  
28 Derick Coetzee Street  
Boksburg 1459  
Phone: +27 / 11 / 397 3665  
sales@az-armaturen.co.za  
www.az-armaturen.co.za

### Plant USA

AZ VALVES North America L.P.  
18702 Intercontinental Crossing Drive  
Houston, TX 77073  
Phone: +1 / 832 / 827 2163  
sales@azvalves.com  
www.azvalves.com

### Plant Saudi Arabia

AZ Valves Arabia Manufacturing Co.  
Building No. 4066  
Street 26, Cross 09  
Dammam, Kingdom of Saudi Arabia  
Phone: +966 / 13 835 1880  
info@azvalves.com.sa

## AZ services

### Europe

- Germany (Moenchweiler & Rhineland)
- France (Lyon/ Bourg-lès-Valence)
- Great Britain (York/Roecliffe)
- Italy (Milan/Caltignaga)
- Poland (Warsaw/Opoczno)
- The Netherlands (Amsterdam)
- Russia (St. Petersburg)

### America

- USA (Houston/TX)
- Brazil (São Paulo, Itatiba & Belem)
- Chile (Santiago de Chile)
- Mexico (Mexico-City)
- Peru (Lima)

### Middle East

- Saudi Arabia (Dammam)

### Asia

- China (Taicang)
- South Korea
- Thailand (Rayong)
- Vietnam (Hanoi)

### Africa

- South Africa (Johannesburg)



Detailed addresses  
on our website

[www.az-armaturen.com](http://www.az-armaturen.com)